

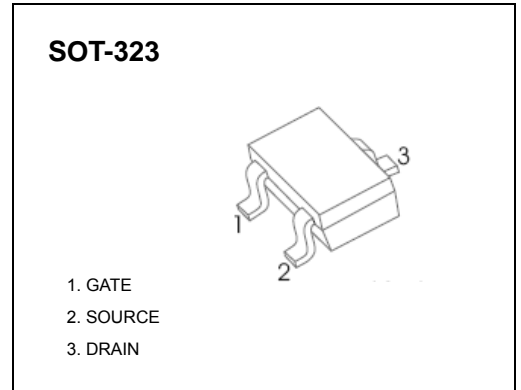

SOT-323 Plastic-Encapsulate MOSFETS

CJ3134KW N-Channel MOSFET

$V_{(BR)DSS}$	$R_{DS(on)MAX}$	I_D
20V	380 mΩ@4.5V	0.75A
	450 mΩ@2.5V	
	800mΩ@1.8V	



FEATURE

- High-Side Switching
- Low On-Resistance
- Low Threshold
- Fast Switching Speed

APPLICATION

- Drivers:Relays, Solenoids, Lamps, Hammers, Displays, Memories
- Battery Operated Systems
- Power Supply Converter Circuits
- Load/Power Switching Cell Phones, Pagers

MARKING



Equivalent Circuit

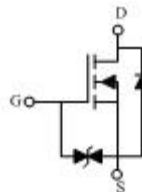

Maximum ratings ($T_a=25^{\circ}C$ unless otherwise noted)

Parameter	Symbol	Value	Unit
Drain-Source voltage	V_{DSS}	20	V
Typical Gate-Source Voltage	V_{GS}	±12	
Drain Current-Continuous	I_D	0.75	A
Drain Current -Pulsed(note1)	I_{DM}	3	
Power Dissipation (note 2)	P_D	200	mW
Thermal Resistance from Junction to Ambient	$R_{\theta JA}$	625	$^{\circ}C/W$
Storage Temperature	T_j	150	$^{\circ}C$
Junction Temperature	T_{stg}	-55 ~+150	

MOSFET ELECTRICAL CHARACTERISTICS

$T_a=25^\circ\text{C}$ unless otherwise specified

Parameter	Symbol	Test Condition	Min	Typ	Max	Unit
On/Off States						
Drain-Source Breakdown Voltage	$V_{(BR)DSS}$	$V_{GS} = 0V, I_D = 250\mu A$	20			V
Gate-Threshold Voltage(note 3)	$V_{GS(th)}$	$V_{DS} = V_{GS}, I_D = 250\mu A$	0.35		1.1	
Gate-Body Leakage Current	I_{GSS}	$V_{DS} = 0V, V_{GS} = \pm 10V$			± 20	μA
Zero Gate Voltage Drain Current	I_{DSS}	$V_{DS} = 20V, V_{GS} = 0V$			1	μA
Drain-Source On-State Resistance(note 3)	$R_{DS(on)}$	$V_{GS} = 4.5V, I_D = 650mA$			380	m Ω
		$V_{GS} = 2.5V, I_D = 550mA$			450	
		$V_{GS} = 1.8V, I_D = 450mA$			800	
Forward Transconductance	g_{fs}	$V_{DS} = 10V, I_D = 800mA$	1			S
Dynamic Characteristics(note 4)						
Input Capacitance	C_{iss}	$V_{DS} = 16V, V_{GS} = 0V, f = 1MHz$			120	pF
Output Capacitance	C_{oss}				20	
Reverse Transfer Capacitance	C_{rss}				15	
Switching Times (note 4)						
Turn-On Delay Time	$t_{d(on)}$	$V_{DD} = 10V, I_D = 500mA,$ $V_{GS} = 4.5V, R_G = 10\Omega$		6.7		ns
Rise Time	t_r			4.8		
Turn-Off Delay Time	$t_{d(off)}$			17.3		
Fall Time	t_f			7.4		
Drain-Source Diode Characteristics						
Drain-Source Diode Forward Voltage (note 3)	V_{SD}	$I_S = 0.15A, V_{GS} = 0V$			1.2	V

Notes:

1. Repetitive Rating: Pulse width limited by maximum junction temperature.
2. This test is performed with no heat sink at $T_a=25^\circ\text{C}$.
3. Pulse Test : Pulse Width $\leq 300\mu s$, Duty Cycle $\leq 0.5\%$.
4. These parameters have no way to verify.

Typical Characteristics

Output Characteristics

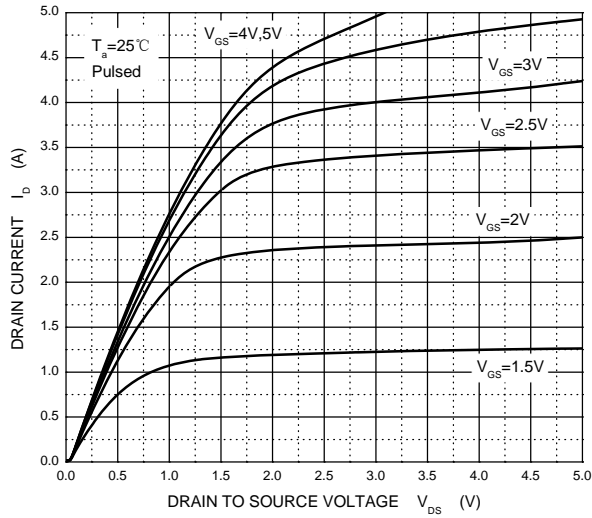

Transfer Characteristics

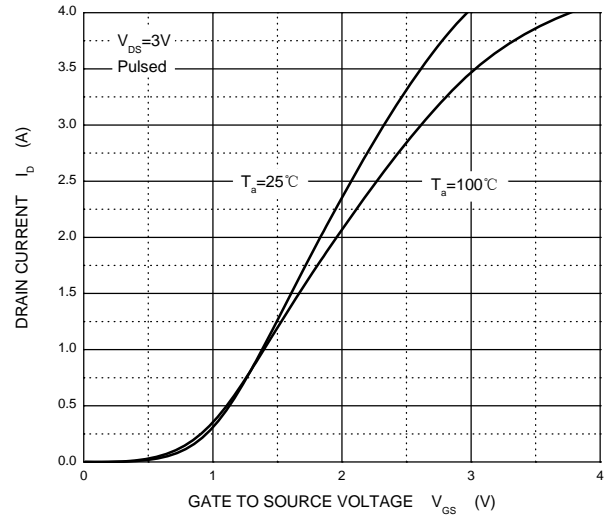

$R_{DS(ON)}$ — I_D

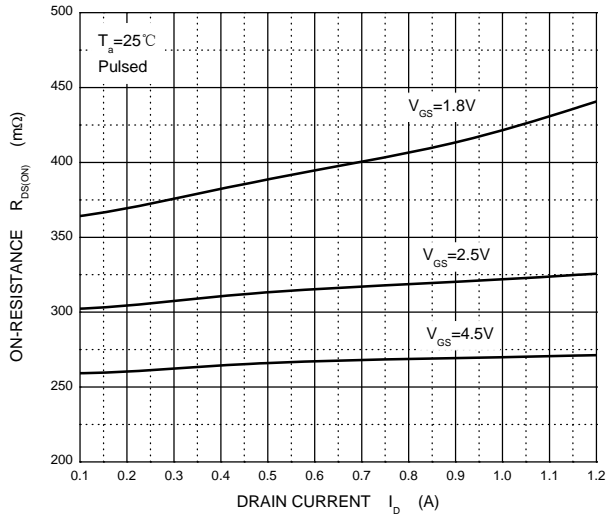

$R_{DS(ON)}$ — V_{GS}

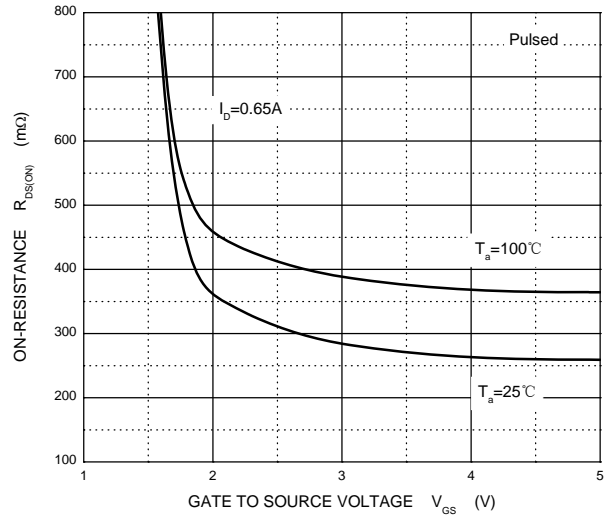

I_S — V_{SD}

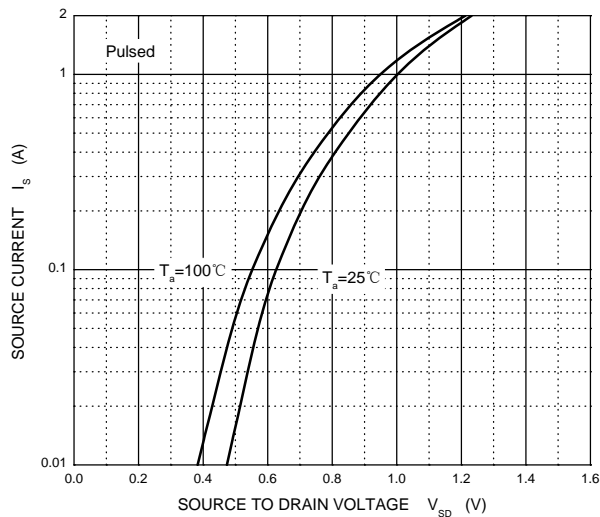

Threshold Voltage

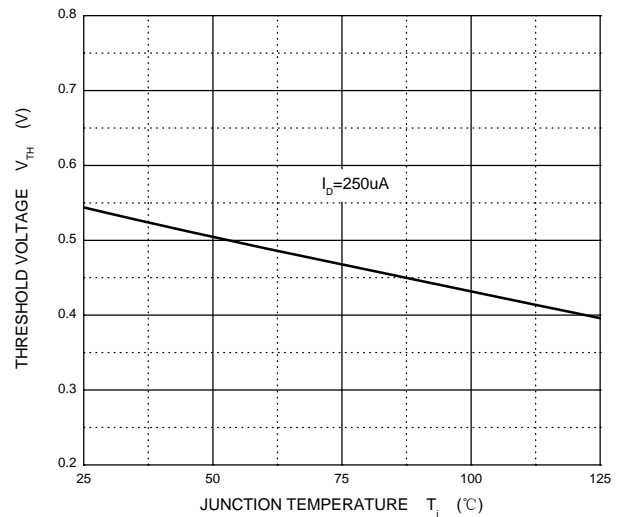

SOT-323 Package Outline Dimensions

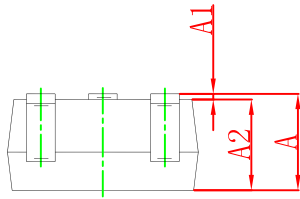
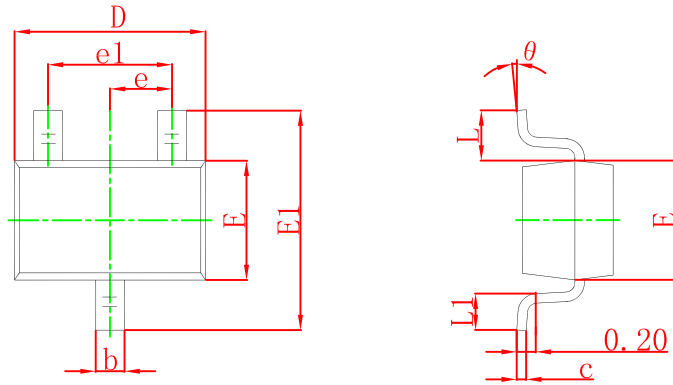

Symbol	Dimensions In Millimeters		Dimensions In Inches	
	Min	Max	Min	Max
A	0.900	1.100	0.035	0.043
A1	0.000	0.100	0.000	0.004
A2	0.900	1.000	0.035	0.039
b	0.200	0.400	0.008	0.016
c	0.080	0.150	0.003	0.006
D	2.000	2.200	0.079	0.087
E	1.150	1.350	0.045	0.053
E1	2.150	2.450	0.085	0.096
e	0.650 TYP		0.026 TYP	
e1	1.200	1.400	0.047	0.055
L	0.525 REF		0.021 REF	
L1	0.260	0.460	0.010	0.018
θ	0°	8°	0°	8°

SOT-323 Suggested Pad Layout

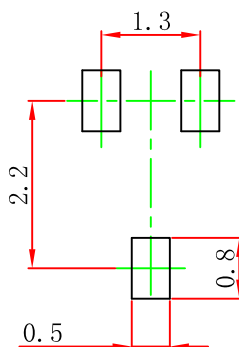

Note:

1. Controlling dimension: in millimeters.
2. General tolerance: ± 0.05 mm.
3. The pad layout is for reference purposes only.

NOTICE

JCET reserve the right to make modifications, enhancements, improvements, corrections or other changes without further notice to any product herein. JCET does not assume any liability arising out of the application or use of any product described herein.

627 7DSH DQG UHHO

627 (PERVVHG &DUULHU 7DSH

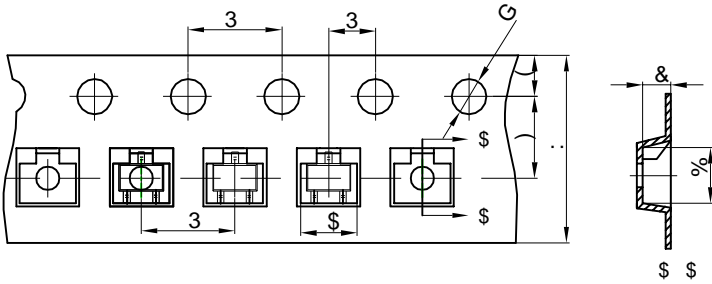

3DFNDJLQJ 'HVFULSWLRQ
 627 SDUWV DUH VKLSSHG LQ WDS
 WDSH LV PDGH IURP D GLVVLSDWLYH FDI
 SRO\FDUERQDWH UHVLQ 7KH FRYHU WDS
 ILOP +HDW \$FWLYDWHG \$GKHVLYH LQ QD
 FRPSRVHG RI SRO\HVWHU ILOP DGKHVLY
 DQG DQWL VWDWLF VSUD\HG DJHQW 7KH
 VWDQGDUG RSWLRQ DUH VKLSSHG ZLWK
 RU FP GLDPWHU UHHO 7KH UHHOV D
 DQG LV PDGH RI SRO\WV\UHQH SODVWLF
 FRDWHG

'LPHQVLRQV DUH LQ PLOOLPHWHU										
3NJ W\SH	\$	%	&	G	()	3	3	3	:
627										

627 7DSH /HDGHU DQG 7UDLOHU

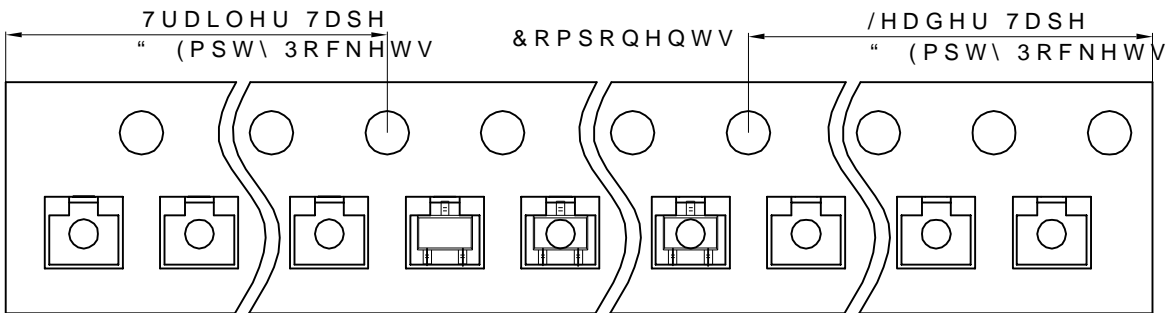

627 5HHO

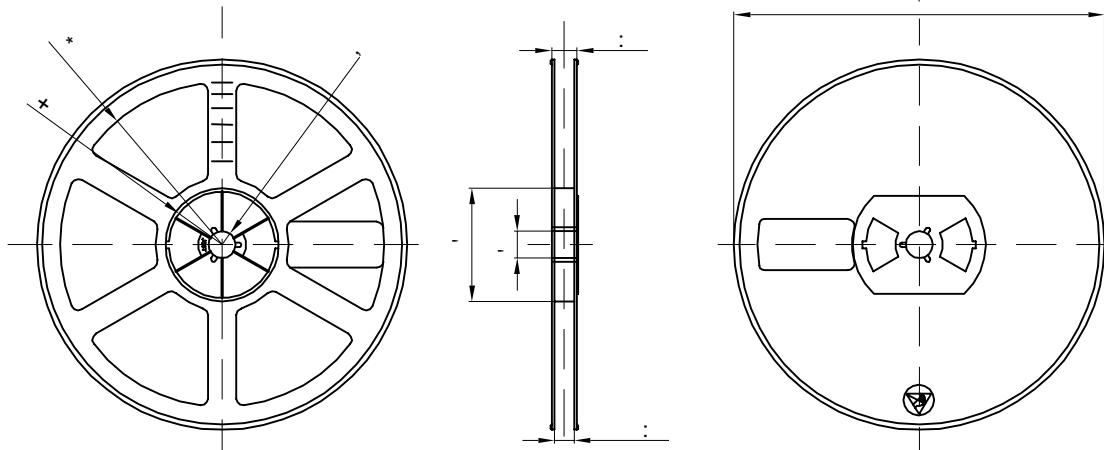

'LPHQVLRQV DUH LQ PLOOLPHWHU									
5HHO 2S\WLRQ				*	+	,	:	:	:
'LD				5	5	5			

5((/	5HHO 6L]H	%R[%R[6L]H	PP &DUWRQ	&DUWRQ 6L]H*	P:P NJ
SFV	LQFK	SFV	↑ ↑	SFV	↑ ↑	